

KMN-RANCAR-FME21A

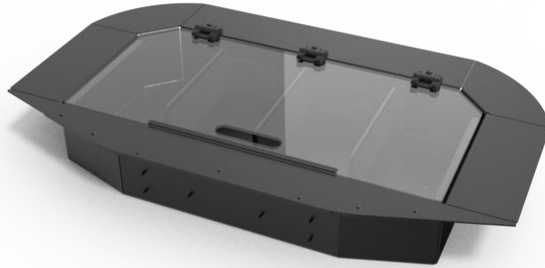

## Trunk Floor Storage Unit

Installation manual

Ford Mach-E 2021+



## Copyright Notice

© Cyberkar<sup>®</sup> Systems, 2024

No part of the documentation materials accompanying this Cyberkar<sup>®</sup> Systems software product may be reproduced, transmitted, transcribed, stored in a retrieval system, sold, exploited commercially or translated into any language or computer language, in any form or by any means, including, but not limited to, electronic, magnetic, optical, chemical, manual, or otherwise without prior written permission of Cyberkar<sup>®</sup> Systems.

The contents of this documentation are protected by applicable copyright laws and will be distributed with a software that includes an end-user license agreement.

The information contained herein is provided for informational purposes only and is subject to change without notice. Cyberkar<sup>®</sup> Systems assume no responsibility or liability for any errors or inaccuracies that may appear in the informational content contained in this document.

Cyberkar<sup>®</sup> Systems, Cyberkar<sup>®</sup> and Kommander<sup>®</sup> logos are trademarks of Cyberkar<sup>®</sup> Systems in the United States and Canada. Other trademarks used in this document may be trademarks of the manufacturers or vendors of the respective products.

### Cyberkar<sup>®</sup> Systems

---

Address: 3026 Anderson, suite 202  
Terrebonne, Quebec, J6Y 1W1  
Canada

---

Toll-free number: 1-855-951-3080

---

E-mail: [info@cyberkar.com](mailto:info@cyberkar.com)

---

## Table of Content

<b>1 WORK TIME.....</b>	<b>4</b>
<b>2 EXPLODED VIEW.....</b>	<b>5</b>
<b>3 PARTS INCLUDED .....</b>	<b>6</b>
<b>4 HARDWARE BAG .....</b>	<b>7</b>
<b>5 PREPARING TO INSTALL.....</b>	<b>8</b>
<b>6 INSTALLATION .....</b>	<b>12</b>
<b>7 TECHNICAL SUPPORT .....</b>	<b>20</b>

# 1 WORK TIME

---

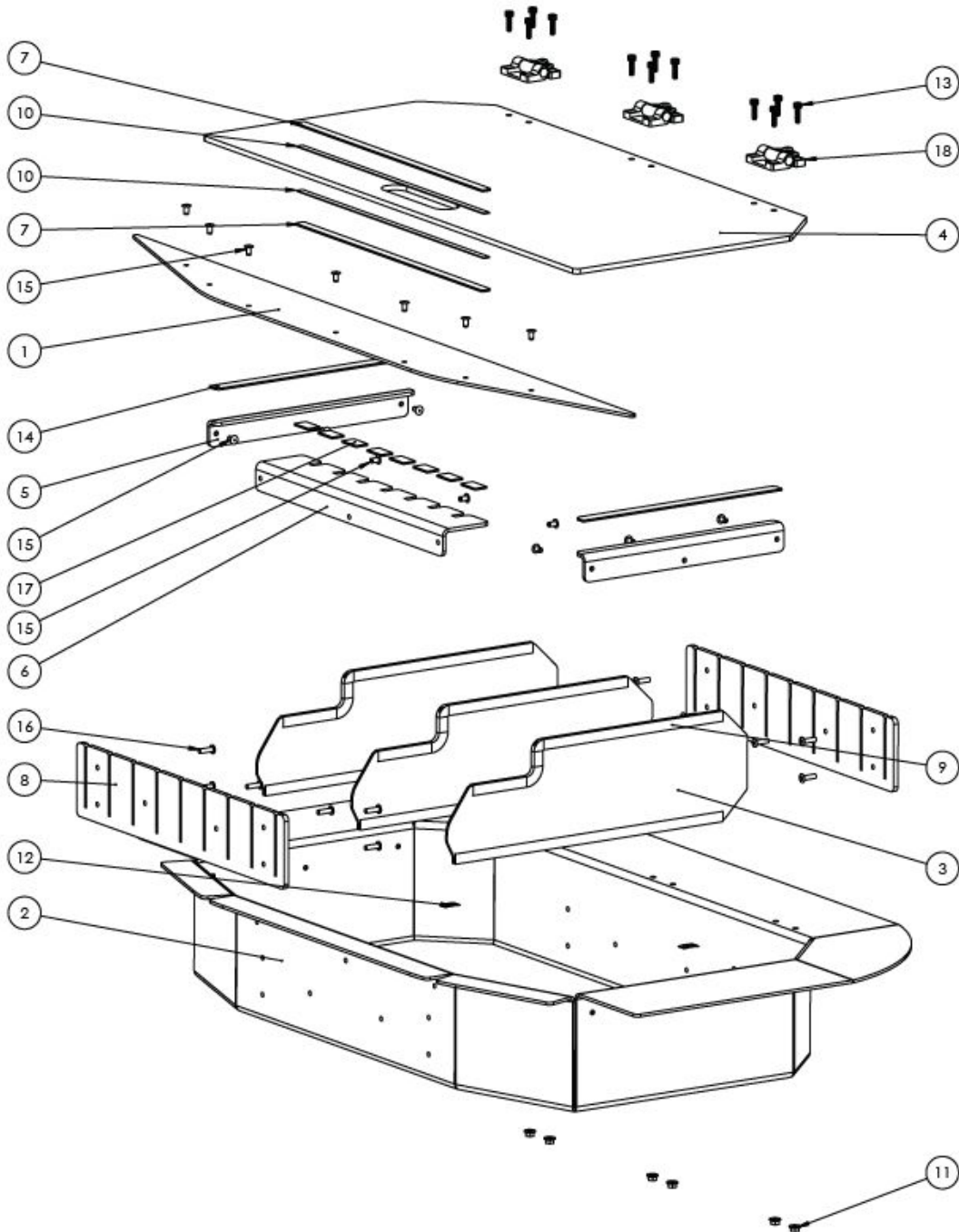

Installation time	
	30 minutes
	50 minutes (alternate method)

## 2 EXPLODED VIEW



## 3 PARTS INCLUDED

---

#	N° / SKU	DESCRIPTION	QT	IMG
3	FA00007648-M-10052	Separator plate	3	
22	KMN-RANCAR-BTE-FME21A	Storage box assembly	1	
	KMN-HB-RANCAR-FME21A	Hardware bag	1	

---

## 4 HARDWARE BAG

#	N° / SKU	DESCRIPTION	QT	IMG
12	MCMASTER_90528A125	Rectangular retaining ring	2	
19	MCMASTER_92137A550	Flanged button head screw, M6 x 1.00 mm, 35mm Long	2	
20	MCMASTER_93413A140	Washer M6, 6.4 mm ID, 12 mm OD	2	
21	MCMASTER_90593A005	Hex nut, Class 8, M6 x 1 mm	2	

## 5 PREPARING TO INSTALL

---

- 1 Remove the removable floor.





- 2** Remove items 1, 2 and 3 from the vehicle.

You can keep them if you want to put the vehicle back in its original condition later on.



- 3** Unclip the 2 anchor caps then remove the screw from each using a Torx T25 socket.

Save the hooks for future reinstallation.



**4** Result of the operation.



**5** Use an 8 mm socket to remove the 2 inner screws.



- 6** Cut the bottom of the vehicle foam using the red line.

If alternative installation mode is used (*keep vehicle back plate*), this step is not required.



## 6 INSTALLATION

---

- 1 Cut out the foam in the bottom of the trunk as in the photo.



- 2 Put the storage box in place (part #22), including the separator plates (part #3).

The 2 original vehicle screws should line up with the 2 holes in the bottom of the storage box.

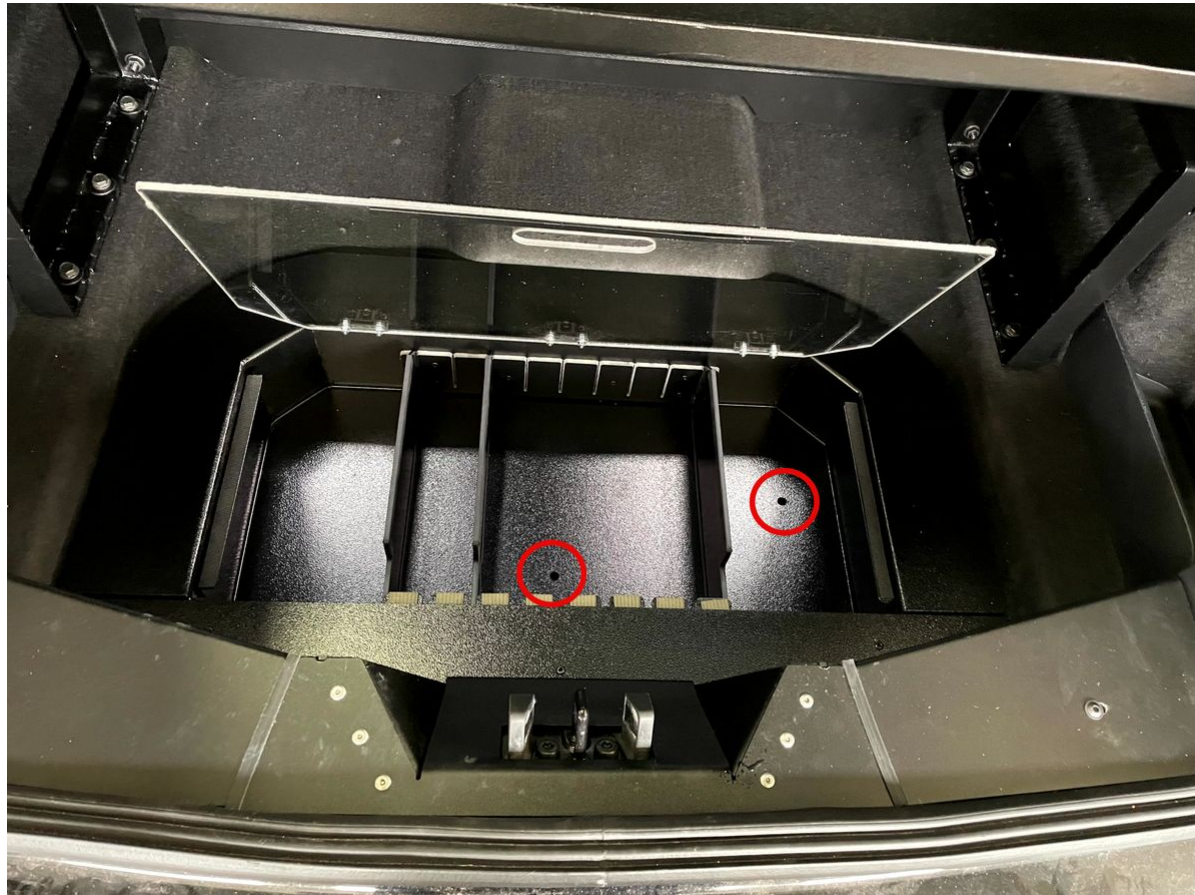

- 3** Insert the 2 rectangular retaining rings (item #Q12) to hold the storage unit.



- 4 Adjust the closing resistance of the hinges using a screwdriver.



1



**Alternate method:  
Keeping the vehicle  
bottom plate**

*(Requires 20 minutes of  
additional work)*

Measure, mark and cut the bottom panel of the vehicle according to the solid red line in the diagram.

The red dotted line at the top will need to be cut out if the rear partition is present.

An additional cutout is required on each side for the partition supports.

Measure the final position of these supports, mark them and cut them out.

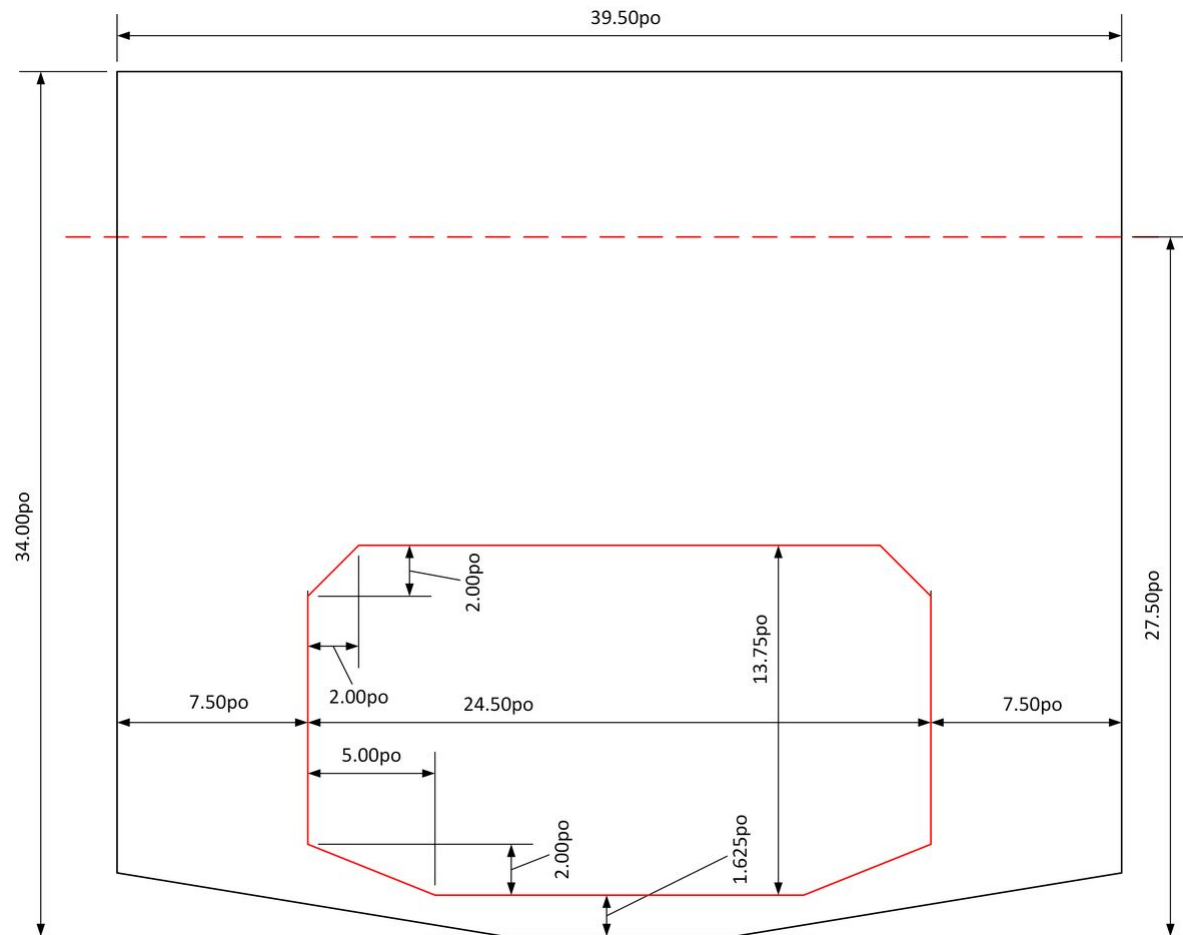



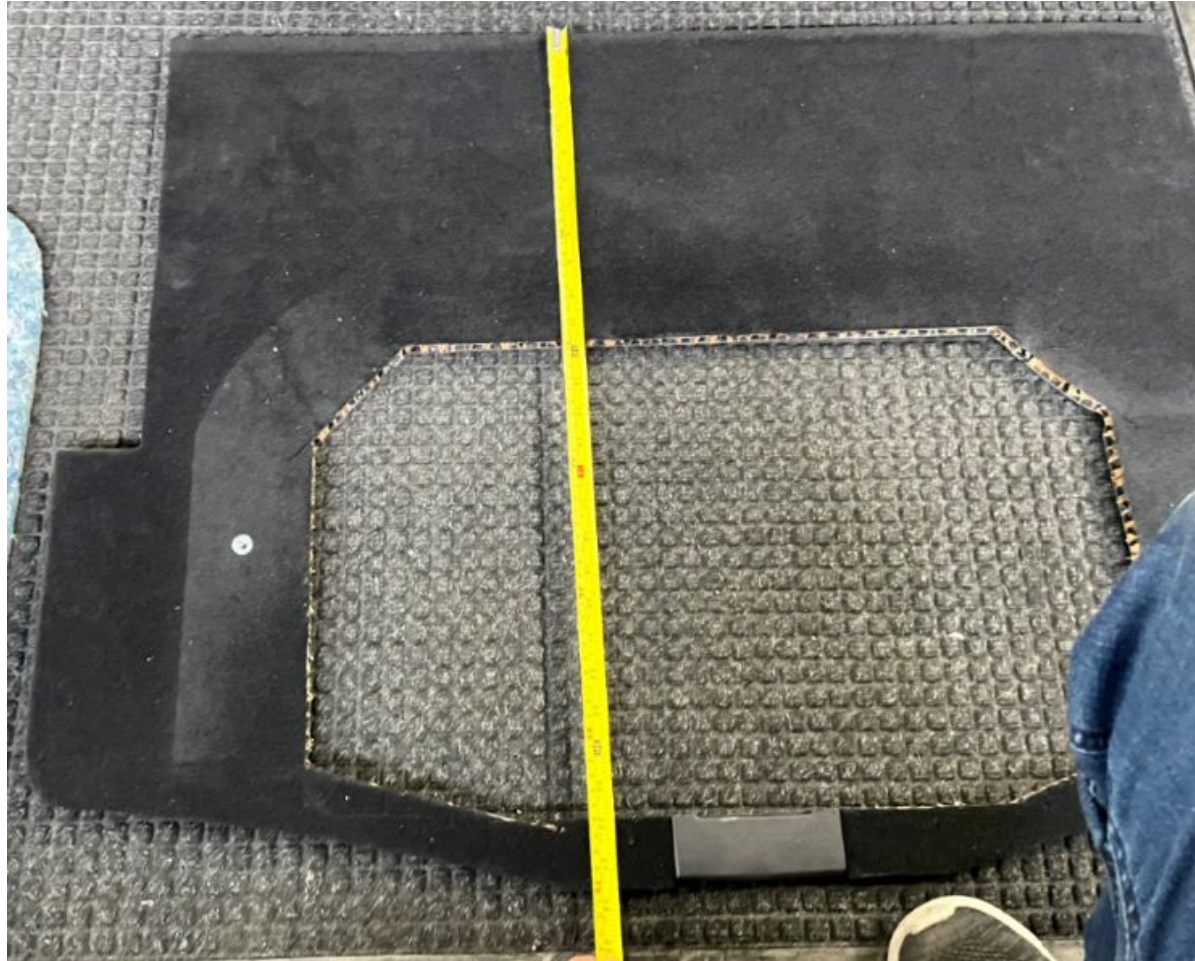

- 2 Place the storage box on the tray and drill a hole in each side using a 1/4" drill bit.

Drill the metal of the trunk and the panel.

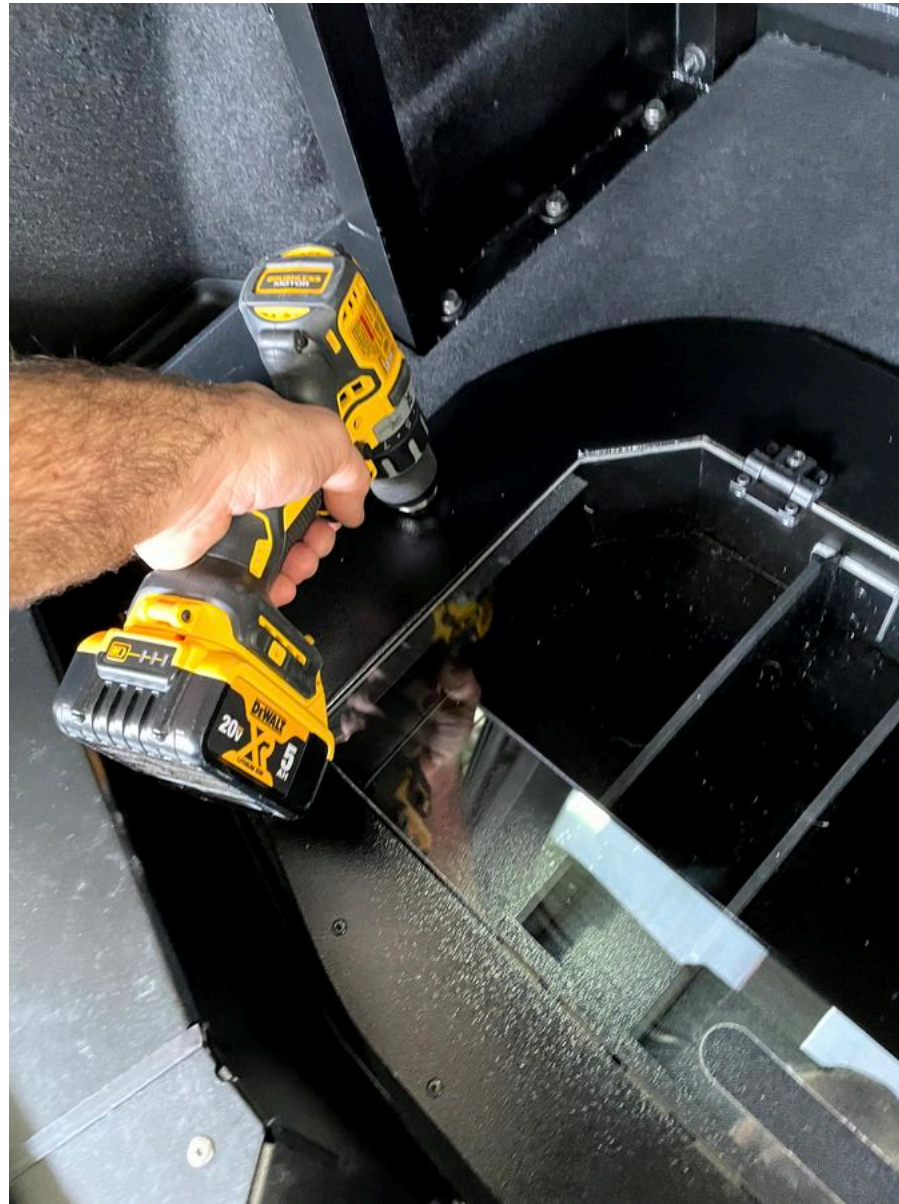

- 3** Secure the box using 2 screws, 2 washers and 2 nuts (items #Q19, #Q20 and #Q21) by lifting the panel then putting it back in place once fixed.

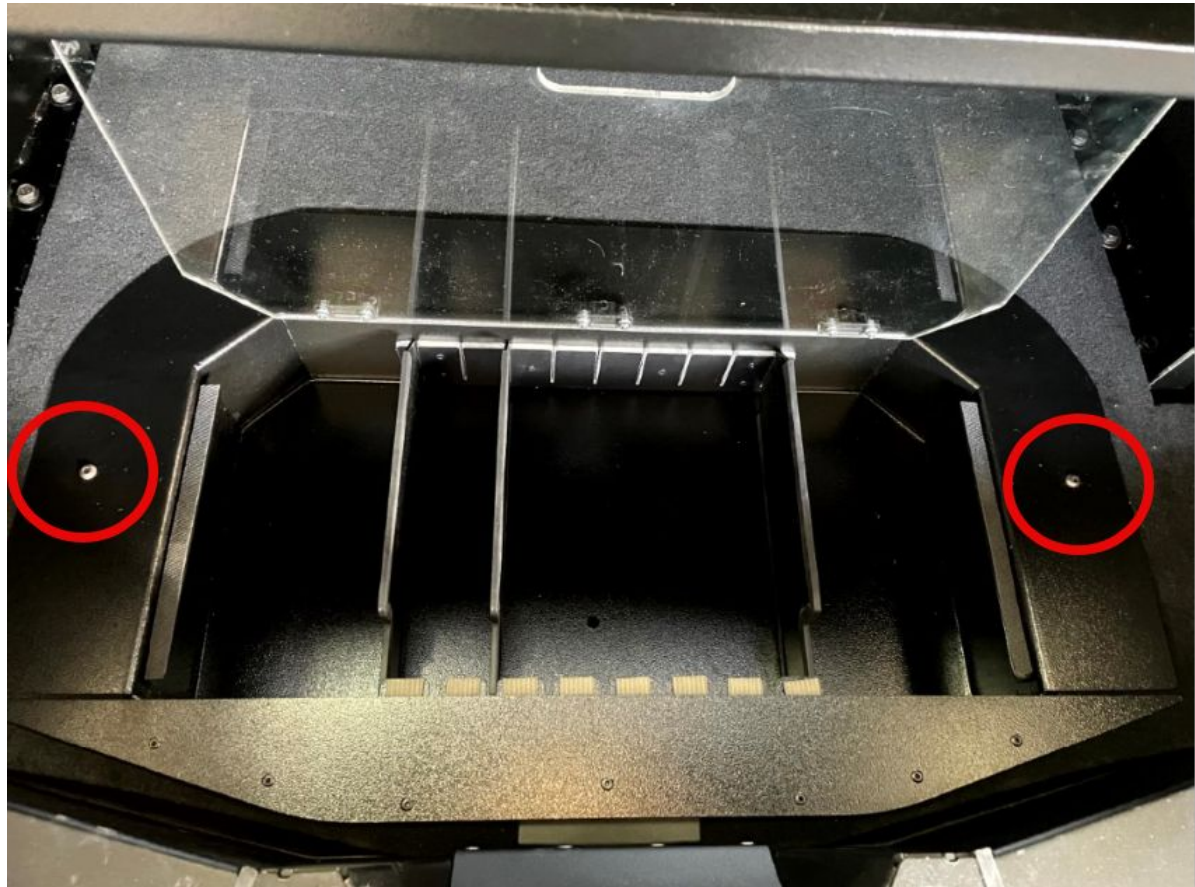

## 7 TECHNICAL SUPPORT

---

### Cyberkar<sup>®</sup> Systems

---

Address: 3026 Anderson, suite 202  
Terrebonne (Quebec) J6Y 1W1  
Canada

---

Toll-free number: 1-855-951-3080

---

### Tech support team

---

Days/hours of operation: Monday to Friday, 8 a.m.—5 p.m. (EST).

---

Escalation process: E-mail is used for escalations outside of hours of operation.

---

E-mail: [support@cyberkar.com](mailto:support@cyberkar.com)

---





Installation manual (rev. 5)

© All rights reserved, Cyberkar® Systems, 2024

[www.kommanderbycyberkar.com/en/](http://www.kommanderbycyberkar.com/en/)

Trunk Floor Storage Unit

Ford Mach-E 2021+

KMN-RANCAR-FME21A